

EPT15H/EPT20H

LITHIUM PALLET TRUCK

24 HOURS
BUILT TO WORK



SMART POWERFUL DURABLE

BUILT TO WORK

24

HOURS

SMART SIZE

ALMOST SAME



LIGHT WEIGHT



EFFICIENCY

3 Times Higher Than Manual Pallet Truck

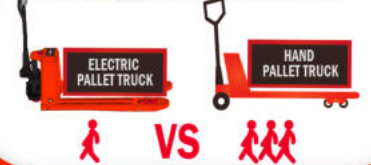

EASY MAINTENANCE



LIFETIME

3 Times Longer Than Manual Pallet Truck

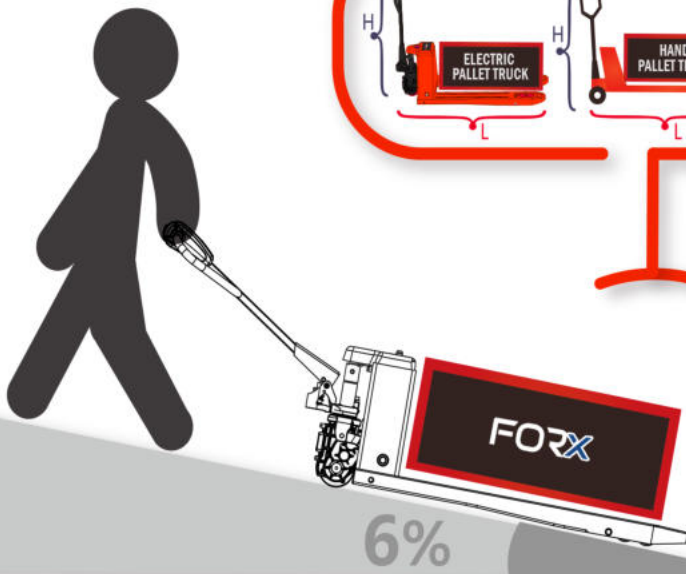
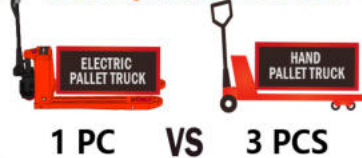

HIGH RETURN OF INVESTMENT

Safety

PRODUCTIVE

1 MONTH COST RECOVERY

Optimize your operations
SAVE LABOUR
Brake any time anywhere

Release manpower

Powerful With High Gradeability



Unique brushless technology

Brushless motor, powerful and maintenance free.
Leading in the industry.



750W/1000W power
Brushless motor
Maintenance free



Powered traveling



Powered lifting & lowering

Maintenance free

For brushed motor, carbon brush needs to be replaced every 12 or 18 months.
For EPT15H, no need to replace carbon brush.
Maintenance-free, saving maintenance time and cost.

Powerful with high gradeability

To easily move 1.5 ton or 2 ton over the slopes at warehouse entrances.

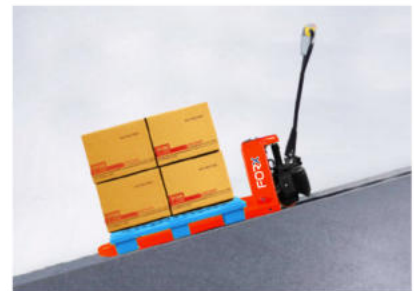

Traveling speed

— **UNLADEN** 4.5km/h

+ **LADEN** 4km/h



Gradeability



Non-stop Working

6s to replace battery

Maintenance-free lithium battery
It takes only 6s to replace battery.
With a spare battery, the unit can keep working 24 hours.

Ensured battery safety

Safe and reliable, no fire, no explosion.
Complying with IEC, UL global standard certification requirements, ensuring the safety of user property.

- Long service life: lithium battery with a long service life.
- High safety performance: it adopts soft package battery technology, built-in protection board and multiple protection to eliminate overcharge and overdischarge.
- Maintenance free: no need to add water.

Compact and durable

Solid build, no breaking

Chassis made by solid materials, no bending, no deformation.
Reinforced rocker arm, push rod, wheel frame and support seat.
No plastic part, less damage.

Most compact unit with same lifting capacity

Suitable for small workplaces such as compact workshops, trucks or vans, tail lifts or elevators.
EPT15H has the smallest turning radius among similar products.

Integral forks, no splicing

The forks are uniquely designed, easy to handle European pallets, American pallets and plastic pallets.
Solid fork with no deformation, far more durable than other brands of the same category.

Short charging time Charge and use freely

Quick charging: 2 hours to fully charge the battery.



**Solid build
No breaking**

Top cap thickness

6mm

V-block thickness

5mm

Fork thickness

4mm



Intelligent Control

When you're moving heavy loads in tight spaces, maneuverability and controllability are critical to ensure safety, productivity and comfort.

The core concept of FORX products is to make your job easier. With the ergonomically designed handle, EPT15H is easy to operate, reduces fatigue and improves work efficiency. Compared to other brands, users prefer to use FORX EPT series.



Operator Preferred

Turtle Speed

01

Horn Remains Pressed & Forward 2 times

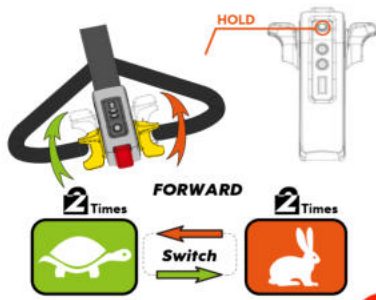

Up-Right Drive

02

Reverse Button & Forward Throttle Remain Pressed Power On

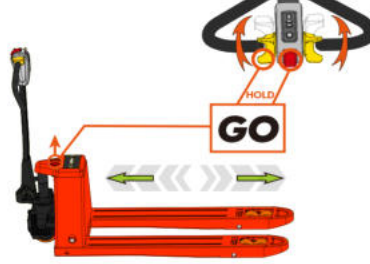

Engineering Mode (Brake Release)

03

Horn Remains Pressed Power On



- ⚠ In up-right drive mode, vehicle will move when handle is operated at any position. Please avoid misoperation.
- ⚠ Brake release mode is only for emergencies, not allowed for vehicle with normal conditions.

Comfortable Operation

Easy to operate
Ergonomic handle, comfortable to use.

Leading Technology

CanBus technology is applied on this entry-level electric pallet truck.

Fast And Slow Speed

To match different levels of operator experience, and varied work environments.

Up-right Drive Mode

Convenient to operate in vans, on tail lifts, or inside elevators.

Engineering Mode

When the unit breaks down, it can be moved away manually.



- Recharge alert
- Hour meter
- Powered traveling
- Powered lifting & lowering
- Error code display
- Emergency stop button
- Horn

Slope anti-sliding design

Easy parking on slopes, preventing accidental backing of the machine.

Easy Maintenance

EPT series utilizes FORX 's integrated diagnostics, error code display and FORX 's original service mini-program to facilitate quick problem resolution.

Easy parts replacement

The unique design makes disassembly and assembly simple, reducing machine downtime and operating costs.

- **1 minute**
Replace the drive wheel
- **1 minute**
Replace the handle
- **2 minutes**
Remove the controller
- **3 minutes**
Remove the motor

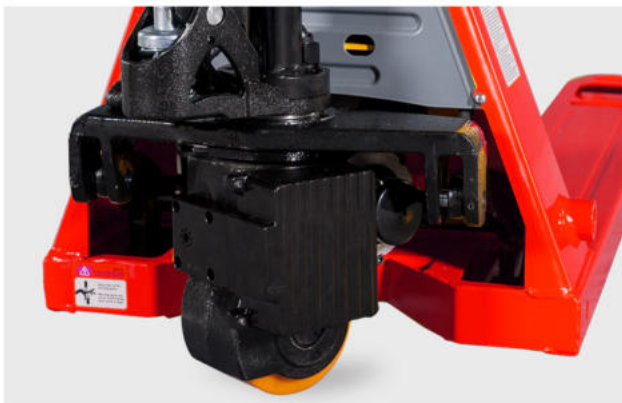

Error Code Display

Quickly identify the fault during operation.



Specialized service website & mini-program

Users can identify the fault based on the online troubleshooting videos. No limit on time, no limit on location. Easy access to the most professional solution to all possible truck failures.

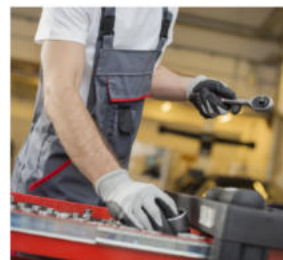

Professional after-sales support

Specialist guidance is a phone call away.

Ready to Handle Multiple Jobs

With its unique design, EPT series is powerful and maneuverable to meet the application in a wide range of working conditions.

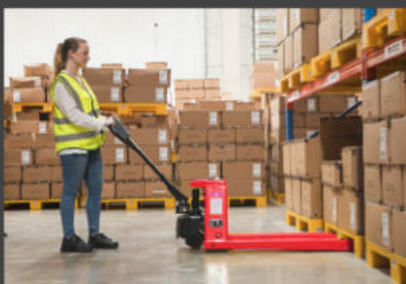

Warehouses/Logistics center



Truck tail lift



Supermarket

Pallet trucks are a necessary investment. Choosing the wrong machine could cause loss in productivity, high cost of machine downtime, unhappy workers, and overall, increased running costs. Choosing EPT series will reward you with long-term value.

FORX EPT Series

- **Powerful**
- **Durable**
- **Easy maintenance**
- **Low use cost**
- **High return on investment**

Basic Configuration

- Horn
- Emergency reverse button
- Forward/reverse butterfly switch
- Lifting / Lowering
- LCD Screen**
 - Battery indicator with hour meter
 - Error code display
 - Recharge alert

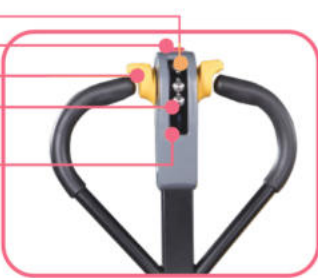

Multi-function Handle (Full Electric)

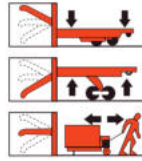

Multi-function Ergonomic Handle (Semi-electric)



Tandem/Single PU wheel



EPT15/20H-65L

EPT15/20H



Low profile forks
Lowered fork height: 65mm
Standard model: 82mm



Lithium Battery



Protection cover
Protect the drive motor,
Anti-foot stamping



Intelligent charger



Electric lifting/lowering



Manual lifting/lowering

Optional Configuration

- Key button
- Upright driving button
- Max speed setting button
- Horn button



Intelligent Control Key



48V 15Ah battery with bigger capacity
Longer working hour



5A fast charger
Shorter charging hour



Wrapping film holder

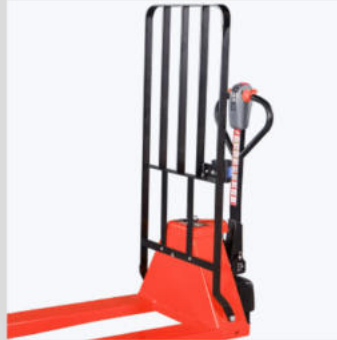

Load backrest

When goods are stacked high, the load backrest can prevent it from falling, ensuring user safety.



Balance wheel

Available on EPT15H/EPT20H



Fork length

800/900/1150/1220/1500/1800 /2000mm fork length options



Fork width

800/900/1000mm fork width options
(For EPT20H)



Dimensions

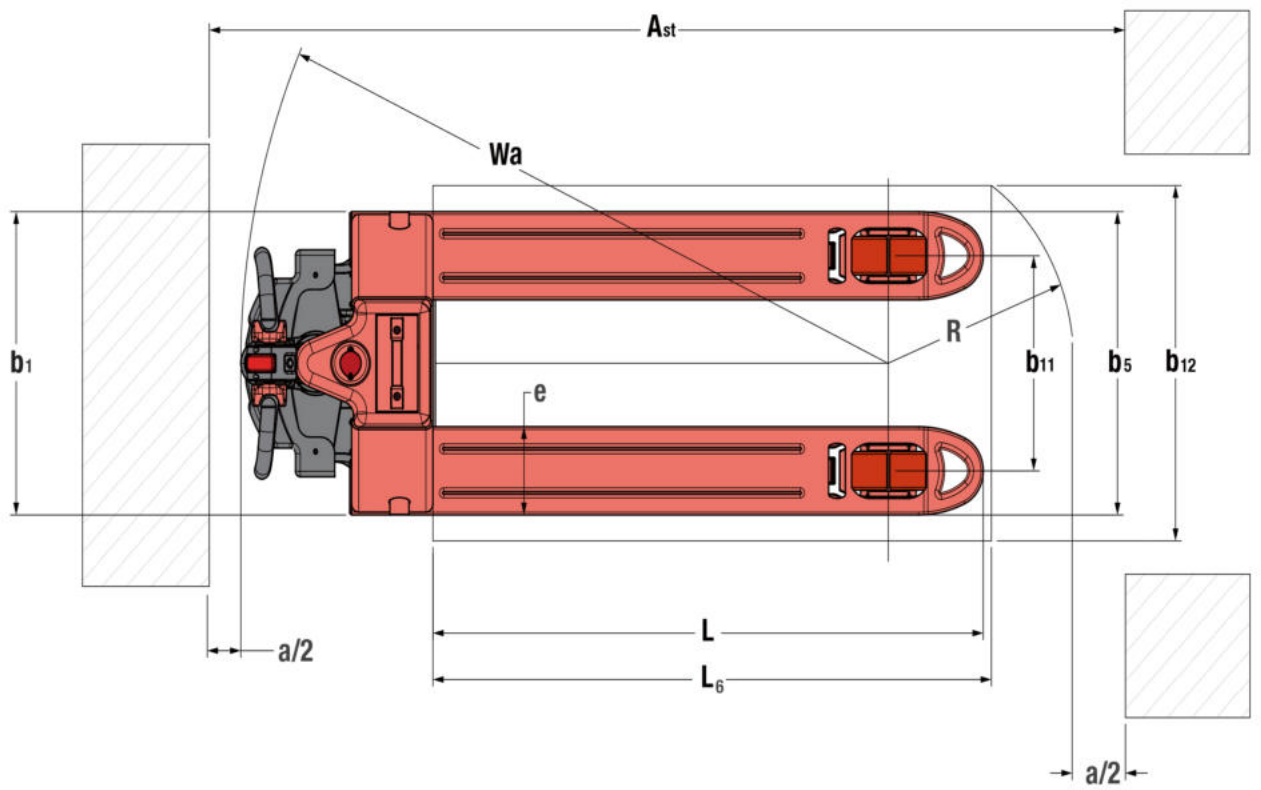
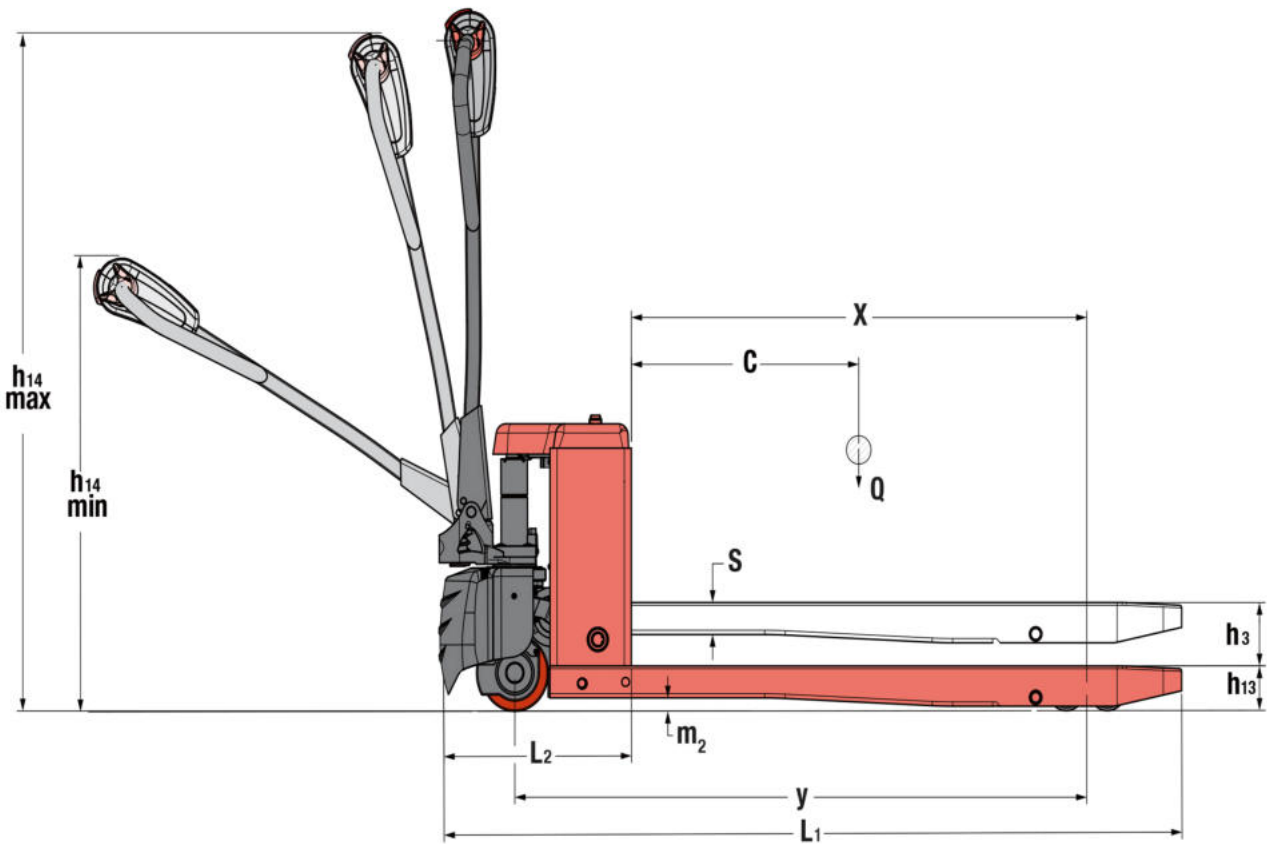

Specifications

MODEL		PPT20H	EPT15H	EPT20H	EPT15H-65L	EPT20H-65L
CHARACTERISTICS						
1.1	Drive		Electric	Electric	Electric	Electric
1.2	Operator type		Pedestrian	Pedestrian	Pedestrian	Pedestrian
1.3	Load capacity/rated load	Q kg	2000	1500	2000	1500
1.4	Load centre	C mm	600	600	600	600
1.5	Height, fork lowered	h ₁₃ mm	82 ± 2	82 ± 2	82 ± 2	65 ± 2
1.6	Wheelbase	y mm	1197/1267	1197/1267	1197/1267	1197/1267
1.7	Wheel		PU	PU	PU	PU
1.8	Wheel size, front	mm	140*55	140*55	140*55	140*55
1.9	Wheel size, rear	mm	80*93 (Single Wheel)	80*93 (Single Wheel)	80*93 (Single Wheel)	60*93 (Single Wheel)
		mm	80*70 (Tandem)	80*70 (Tandem)	80*70 (Tandem)	60*70 (Tandem)
1.10	Wheels, number front/rear (x = drive wheels)		1x+2/4	1x+2/4	1x+2/4	1x+2/4
1.11	Lift	h ₃ mm	115	115	115	100
1.12	Height of tiller in drive position, min./max.	h ₁₄ mm	735/1170	735/1170	735/1170	735/1170
1.13	Overall length	L ₁ mm	1552/1622	1552/1622	1552/1622	1566/1636
1.14	Fork Length	L mm	1150/1220	1150/1220	1150/1220	1150/1220
1.15	Overall width	b ₁ mm	550/685	550/685	550/685	550/685
1.16	Fork dimensions	mm	58/160/1150(1220)	58/160/1150(1220)	58/160/1150(1220)	45/160/1150(1220)
1.17	Distance between fork-arms	b ₅ mm	550/685	550/685	550/685	550/685
1.18	Ground clearance, centre of wheelbase	m ₂ mm	22/137(24/139)	22/137(24/139)	22/137(24/139)	16.5/116.5(17.2/117.2)
1.19	Aisle width for pallets 1000x1200 crossways	A _{st} mm	2376	2376	2376	2376
1.20	Aisle width for pallets 800x1200 lengthways	A _{st} mm	2257	2257	2257	2257
1.21	Turning radius	W _a mm	1353/1426	1353/1426	1353/1426	1353/1426
PERFORMANCE						
2.1	Travel speed, laden/unladen	km/h	4.0/4.5	4.0/4.5	4.0/4.5	4.0/4.5
2.2	Lifting speed, laden/unladen	mm/s	/	18/23	18/23	18/23
2.3	Lowering speed, laden/unladen	mm/s	/	56/46	56/46	56/46
2.4	Max. gradeability, laden/unladen	%	6%/20%	6%/20%	6%/20%	6%/20%
2.5	Drive motor	kW	DC 1.0 Brushless	DC 0.75 Brushless	DC 1.0 Brushless	DC 0.75 Brushless
2.6	Lift motor	kW	Hydraulic	DC 0.8	DC 0.8	DC 0.8
BATTERY						
3.1	Battery voltage/nominal capacity	V/Ah	48V/10Ah(48V/15Ah)	48V/10Ah(48V/15Ah)	48V/10Ah(48V/15Ah)	48V/10Ah(48V/15Ah)
3.2	Traveling brake		Regenerate	Regenerate	Regenerate	Regenerate
3.3	Brake		Electromagnetic	Electromagnetic	Electromagnetic	Electromagnetic
3.4	Sound level at the driver's ear according to EN 12053	A	< 70dB	< 70dB	< 70dB	< 70dB
3.5	Service weight including battery	kg	117/123.5	116.5/123	119/125.5	116.5/123

MAKE
YOUR JOB
EASIER!



FORX

ENERGY ADVANCE CO.,LTD

77/7 Moo.9 Soi Suwinthawong 33 Suwinthawong Road , Lampakchee , Nongchok , Bangkok 10530

Tel : 02-543-7289

Email : Service@energyadvance.co.th

www.forx.co.th